

Cap Screws, Nuts & Washers

Order number	Size	Description
M10LW	M10	Washer, lock, zinc
M10NUT	M10	Nut, hex, zinc
M10X30	M10 x 30	Cap screw, hex head, zinc
M12LW	M12	Washer, lock, zinc
M12NUT	M12	Nut, hex, zinc
M12X30	M12 x 30	Cap screw, hex head, zinc
M12X45	M12 x 45	Cap screw, hex head, zinc
M12X55	M12 x 55	Cap screw, hex head, zinc
M12X100	M12 x 100	Cap screw, hex head, zinc
M14LW	M14	Washer, lock, zinc
M14NUT	M14	Nut, hex, zinc, coarse thread
M14X21	M14 x 21 *	Cap screw, hex head, fine thread, zinc * Front wheel lug bolt – 1500D Replaces 194191-14851
M14X25	M14 x 25 *	Cap screw, hex head, coarse thread, zinc, front wheel 3810D *Front wheel lug bolt – 1500 Replaces 26116-140252
M16LW	M16	Washer, lock, zinc
M16NUT	M16	Nut, hex, zinc
M16X30	M16 x 30	Cap screw, hex head, zinc

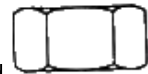

Hydraulic Hoses



HH-518 Hydraulic hose assembly, 1/2" – 2 wire hose 18" long with solid male fittings each end

HH-524 Hydraulic hose assembly, 1/2" – 2 wire hose 24" long with solid male fittings each end

HH-536 Hydraulic hose assembly, 1/2" – 2 wire hose 36" long with solid male fittings each end

HH-548 Hydraulic hose assembly, 1/2" – 2 wire hose 48" long with solid male fittings each end

HH-560 Hydraulic hose assembly, 1/2" – 2 wire hose 60" long with solid male fittings each end

HH-572 Hydraulic hose assembly, 1/2" – 2 wire hose 72" long with solid male fittings each end

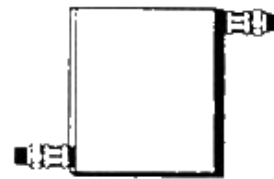

Hydraulic Couplers, Adaptors, and Plugs

PC-12 Coupler, 1/2" female NPT



HA-12 Coupler, 1/2" male NPT



HA-90 Adaptor – 90°, 1/2" NPT female swivel X 3/4-16 ORB male

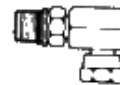

HA-88 Adaptor, swivel 3/4-16 ORB male X 1/2" NPT female swivel

P-12 Plug – 1/2" NPT (5 per bag)



Penetrating Oil

- PO-1543** Super Strength Penetrating Oil – 20oz. can, 15oz. fill
- Frees corroded & rusted parts
 - Fast acting
 - Safe on all metals & alloys

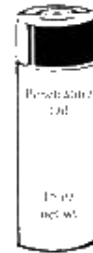

Paint

- SP-Green** Spray paint, **SPRUCE GREEN** for frame and undercarriage touch up. 12oz. net weight
- SP-Red** Spray paint, **RED** for hood and fender touch up. 12oz. net weight.
- GP-Red** Gallon can, **RED**
- SP-White** Spray paint, **WHITE** for side panel, grille and wheel touch up. 12oz. net weight.
- GP-White** Gallon can, **WHITE**
- SP-Primer** Spray paint, **LIGHT GRAY PRIMER**. 12oz. net weight.
- SP-Black** Spray paint, **GLOSS BLACK**. 12oz. net weight.

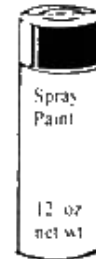

Grease Fittings

GF-6 Grease fitting, 6mm x 1, straight



GF-8 Grease fitting, 8 mm x 1, straight

GF-10 Grease fitting, 10 mm x 1, straight

Drain Plugs

DP-110 Drain plug – M10 Repl. 129350-49120

DP-112 Drain plug – M12, 1401, 1700, 2000 oil plug
Repl. 23491-120002 (old # 124060-01640)



OR-112 O-ring seal for DP-110 & DP-112 Repl. 24311-000140

DP-114 Drain plug – M14 Repl. 23491-140002

OR-160 O-ring seal for DP-114

DP-116 Plug, oil pan drain F series Repl. 105425-01690

DPW-116 Washer, drain plug F series Repl. 22190-160002

- **Weight**
- **Suitcase type**
- **for front bumper**

SW-42 Suit case weight for front bumper
Approx. 42 lbs. *value cannot be counted toward prepaid freight*
Oct. 2004

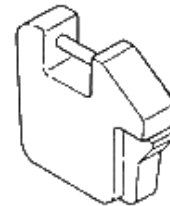

Permatex

- 81878 Permatex Copper RTV silicone, use for 4 cylinder, turbocharged or high performance engines, exhaust manifolds/ headers, valve covers, oil pans, timing covers, water pumps. 3 oz tube.



- 80016 Permatex Form-A-Gasket #2, Temperature range -65° F to 400° F, 3oz tube.



- 80646 Permatex Gasket Remover, 16 oz aerosol can.



- 81158 Permatex BLACK Silicone Adhesive Sealant, 3 oz tube.



- 82180 Permatex ULTRA BLACK gasket maker, use for valve covers, oil pans, intake, manifold end seals, timing covers, transmission pans. -75° F to 600° F.



- 81160 Permatex RED Hi-Temp RTV, 3 oz tube.



Tail Wheel Parts

WS-6	Wheel spacer (2 req'd) Repl. Sitrex 100.006 (1)
WB-8	Wheel bushing Repl. Sitrex 100.008 (2)
WA-165	Wheel Repl. 600.165 (3)
P-794	1/4" lynch pin, 100 per bag (9)
P-7915	5/16" lynch pin, 100 per bag (9)
AB-156	Wheel bolt for TWF-100 (4) Repl. Sitrex 600.156
AN-77	Lock nut for wheel bolt Repl. Sitrex 600.077 (5)

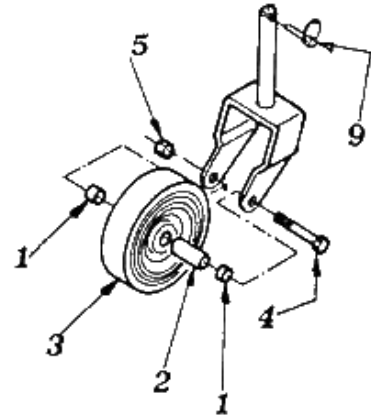

Belt for Finishing Mower

MB-51	Belt for 4' Finish Mower, Sitrex SM120 Repl. Sitrex 600.141
MB-68	Belt for 5' Finish Mower, Sitrex SM150 Repl. Sitrex 600.139
MB-74	Belt for 6' Finish Mower, Sitrex SM180 Repl. Sitrex 600.140

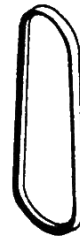

Grease Fittings for Finishing Mower

GFE-125	Grease fitting extension, 3-3/16" for models SM120, SM150, SM180 Repl. Sitrex 100.125
GFE-577	Grease fitting extension, 2-1/4" for models SM120, SM150, SM180 Repl. Sitrex 100.577
GF-8	Grease fitting, 8 mm x 1 straight Repl. Sitrex 600.034

